

TOTAL
WAREHOUSE

Linde Material Handling

Linde

TRUCKS FOR VERY NARROW AISLES

Linde trucks for VNA warehouse tasks
For your performance

TOTAL
WAREHOUSE
TotalWarehouse.com
833-868-2500

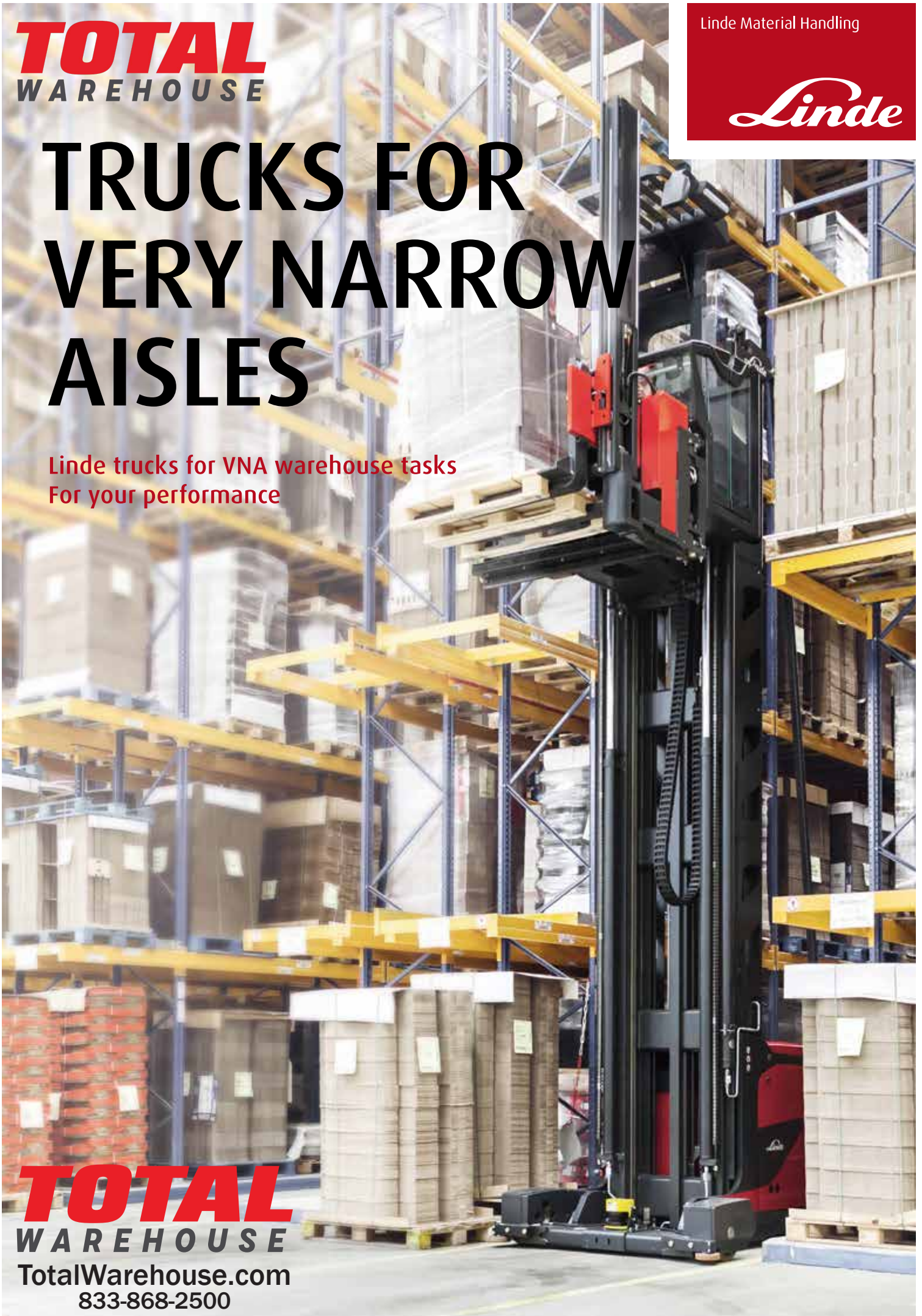

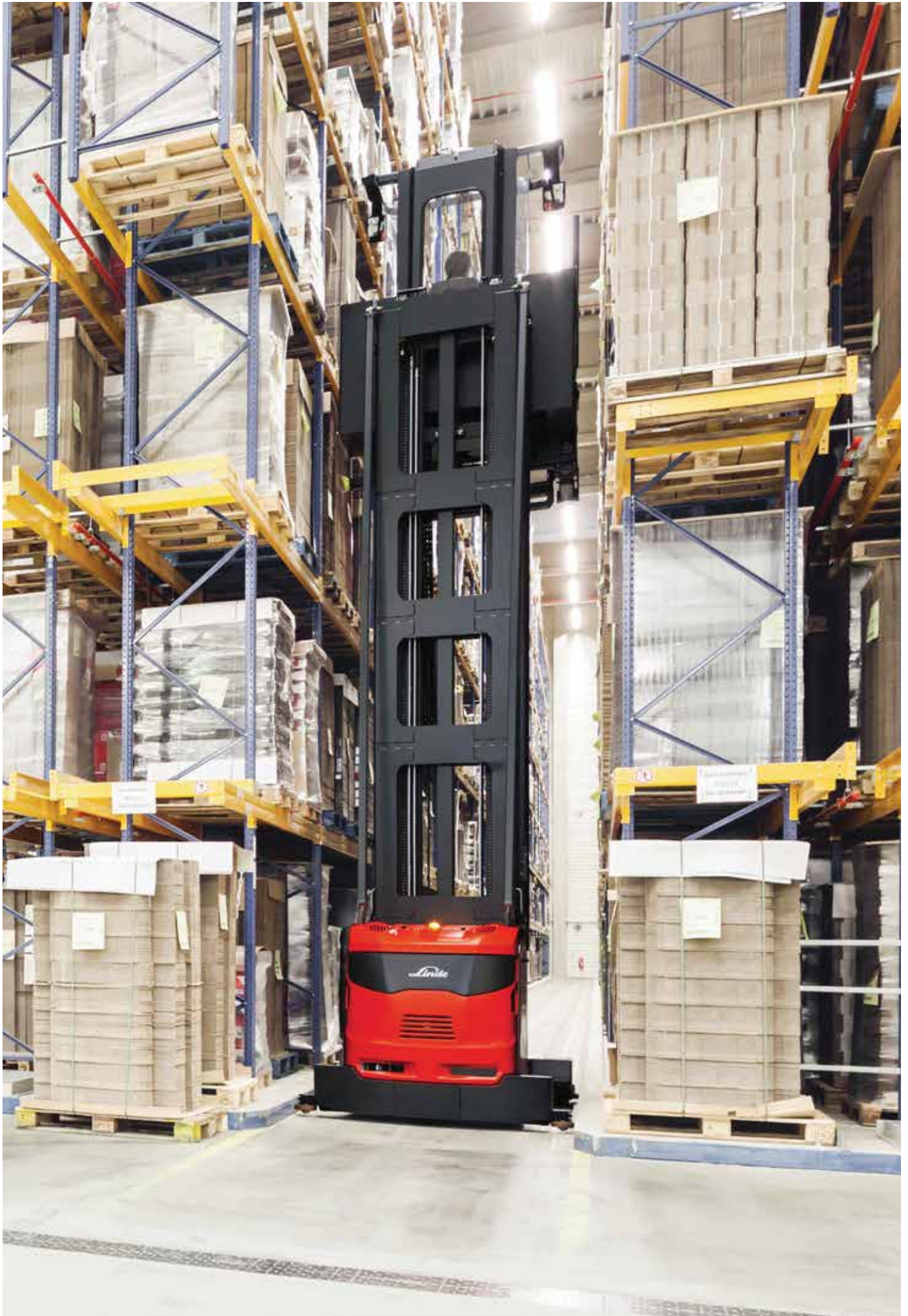

VNA WAREHOUSES – MAXIMISING CAPACITY AND THROUGHPUT

VNA warehousing means you can handle

- more goods
- in less time
- using less space
- with less damage

RESULTING IN HIGHER PRODUCTIVITY

There is an ever-growing need for more **efficient** use of available **space**. This has led many companies to switch to **very narrow aisle (VNA) configurations**.

VNA installations support handling of full pallets, as well as order picking. They are a highly efficient way of organising internal goods flows, enabling **higher throughput**.

- [http://www.linde-mh.com/en/ Products/
Very-Narrow-Aisle-Trucks/](http://www.linde-mh.com/en/Products/Very-Narrow-Aisle-Trucks/)

VNA BENEFITS AT A GLANCE



SPACE

For new-build warehouses, VNA is a highly attractive option, allowing you to make the best possible use of available space. But VNA systems can also make sound economic sense as a retrofit for an existing facility, especially if you are experiencing growing pallet throughput or when greater storage capacity is needed.

How VNA delivers space savings

Conventional warehouse trucks require aisle widths of over 9 ft, but aisle in a VNA warehouse are around 5.5 ft wide. This alone represents a space gain of some 25%. What's more, VNA racking can be constructed substantially higher, with items placed at up to 59 ft where ceilings permit, achieving greater storage density. These two factors combined mean it is possible to increase storage capacity by 50% for pallets with standard loads.



A conventional warehouse served by reach trucks requires an aisle width of over 9 ft.

VNA systems enable pallet storage capacity to be raised by up to 50% compared to conventional racking.

PERFORMANCE

VNA warehouses enable extremely efficient organisation of workflows, greater throughput and high pallet storage density. A specialised VNA truck is capable of simultaneous horizontal travel and vertical lift, giving it a substantial advantage over other truck types. The resulting diagonal movement allows retrieval of a pallet from a height of 33 ft in the same time that it could be moved horizontally at ground level by a conventional truck. This leads to significant time savings and efficiency increases.

Typical throughput for various truck types

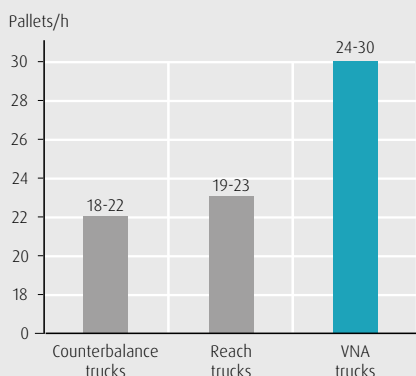

Assuming a racking beam height of 6 m and average work efficiency, counterbalance trucks can move around 18 to 22 pallets per hour. Reach trucks can handle around 19 to 23 pallets per hour (but only 16 in drive-in racking and only 13 in double-deep storage). VNA trucks achieve by far the highest throughput, at 24 to 30 pallets per hour.



SAFETY

VNA trucks are highly stable, enabling precise pallet movements even at significant heights. This means considerably less damage to products and racking. VNA forklifts are therefore ideal for handling high-value goods, and for warehouses where frequent accidents are causing high costs. The truck operates with guides, and the operator remains at eye-level with the load, substantially reducing the risk of accidents.

Cost savings through VNA truck use

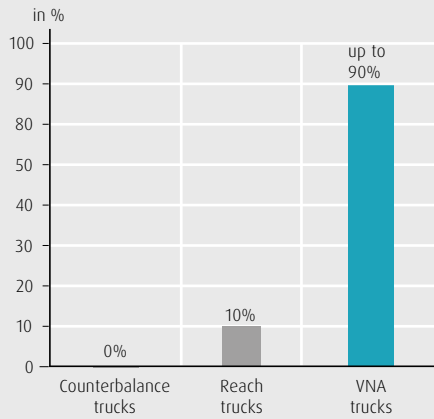

Product and racking damage varies depending on the truck type. The percentages given in the graphic are the maximum savings achievable by replacing a particular model with a VNA. Studies show that VNA truck deployment can slash the cost associated with damage by up to 90%.



VNAP SOFTWARE ALLOWS QUICK AND RELIABLE TRUCK CONFIGURATION



For very narrow aisle applications, factors such as the truck model, the floor, the type of racking, etc. are crucial. Each can have a significant impact on the truck's performance, and each has to be considered in relation to the others.

The Linde very narrow aisle configuration program (VNAP) helps you to create the perfect truck for your business – with user-friendly step-by-step guidance.

The VNAP software analyses the warehouse, its constraints and the requirements of the specific application. Then you select the preferred features of your future truck. And Linde's modular design philosophy means you can create a solution tailored to your imperatives – whether it entails high or medium throughput, medium or high lift

heights, light or heavy loads, order picking or handling of full pallets, or a combination.

Linde's specialist VNA sales professionals will work closely with you to identify the ideal solution for your operational and storage needs – by selecting the most suitable cabin, power package, mast, battery and chassis. And our staff can generate design drawings for you on-site, in your office, to help with your decision making.

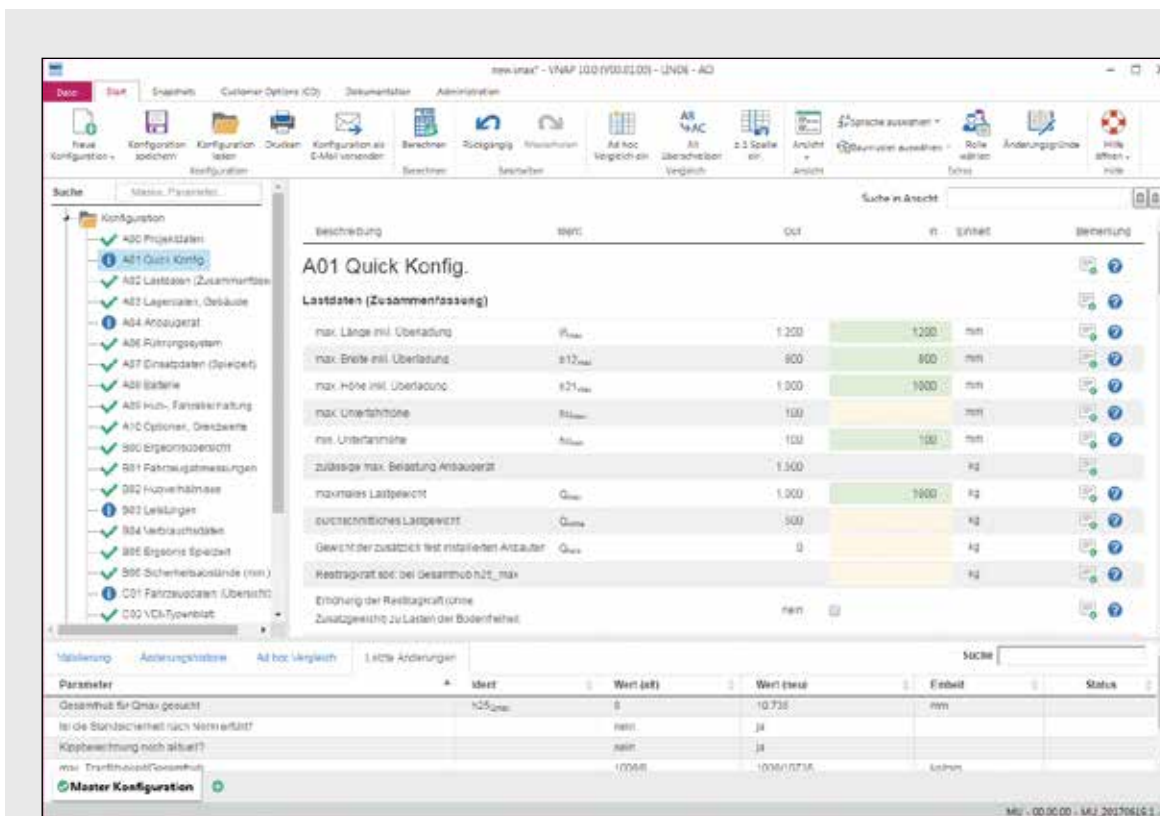

Quick configuration

Designing your perfect truck begins with capturing data on all relevant warehouse and use case parameters. This includes load dimensions and weight, details of racking, type of guidance, battery size, etc. These and other details are entered into our powerful, specialist software tool.



new.unix® - VMAP 100 (V00.01.00) - LINDE - AD

Start | Snapshots | Customer Options (CO) | Dokumentieren | Administration

Neue Konfiguration | Konfiguration speichern | Konfiguration laden | Drucken | Konfiguration als E-Mail versenden | Berechnen | Rückgängig | Neuschätzen | Ad hoc Vergleich ein | Ad hoc Vergleich aus | 2:1 Spalte ein | Ansicht | Sprache auswählen | Spalten ausblenden | Rolle wählen | Änderungen | Hilfe öffnen

Suche in Ansicht

Konfiguration

- ✓ A00 Projektzahn
- ✓ A01 Gurt König
- ✓ A02 Lastzahn (Zusammenbau)
- ✓ A03 Lagerzahn, Gehäuse
- ✓ A04 Antriebsgerät
- ✓ A06 Führungssystem
- ✓ A07 Ersatzdaten (Spielzeit)
- ✓ A08 Bäderle
- ✓ A09 Hub-, Fahrstreckung
- ✓ A10 Optionen, Greifwerke
- ✓ S00 Ergonomisübersicht
- ✓ S01 Fahrwegabmessungen
- ✓ S02 Hubverhältnisse
- ✓ S03 Leertingel
- ✓ S04 Verbrauchstabelle
- ✓ S05 Ergonomis Spielzeit
- ✓ S06 Sicherheitsabstände (mm)
- ✓ S07 Fahrzeugausschnitt (Übersicht)
- ✓ S08 VCA-Typenblatt

A06 Führungssystem

Zwangsführung

Führungstyp:

Zwangsführung nach Bild:

Schiene

Parameter	Wert	Einheit	Status
Lichte Schienenweite	625	1 800 mm	OK
Schienenhöhe	100	mm	OK

Bodenabstände

Parameter	Wert	Einheit	Status
Gesamthöhe für Gmax gesucht	105	mm	OK
Ist die Standhöhe nach Norm erfüllt?	ja		OK
Kippbewehrung nicht aktiviert?	ja		OK
max. Transmissionsleistung	10000	10000/10736	OK

Master Konfiguration

Mi - 00:00:00 - MJ_20170614_1

Detailed configuration
 After collecting all relevant data in the quick configuration, more detailed information, e.g. guidance, can be specified. The software calculates all key parameters, such as travel and lift speed, throughput and power consumption on the spot, and displays the final truck specifications.

PRECISION FOR SPEED AND PRODUCTIVITY: LINDE SYSTEM CONTROL (LSC)



Linde has developed powerful, pioneering technology to ensure optimum control of its VNA man-up and man-down trucks: Linde System Control (LSC).

The standard version employs a sensor to detect the height of the fork, and calculates the maximum residual load capacity. The speed of the truck is automatically adjusted in accordance with the detected height. This all occurs in real time, and is displayed to the operator.

There are also additional optional versions of LSC that employ further sensors to automatically control the speed of travel, lift and other movements in line with the presence of a load, current load weight and lift height.

This powerful technology delivers a significant increase in safety and productivity while reducing damage to trucks and loads. In fact, depending on customer-specific conditions, trucks equipped with LSC can deliver up to 25% greater throughput than conventional forklift models.

What's more, there are a number of additional options above and beyond LSC that can enhance your truck still further.

Dynamic residual load capacity

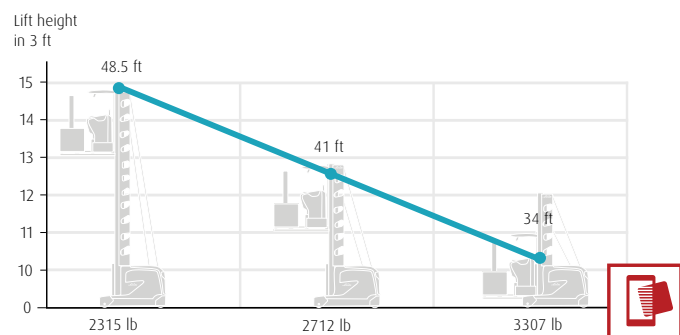

LSC STANDARD

The display shows current maximum load capacity in accordance with the height of the forks. Optimum reach and rotational movements, and reach depth, are calculated in line with lift height. The Linde Curve Assist feature guarantees safety when changing aisles by reducing truck travel speed based on the steering angle.

The benefit: complete transparency into truck load-bearing capacity in accordance with fork height, plus enhanced safety

Load recognition

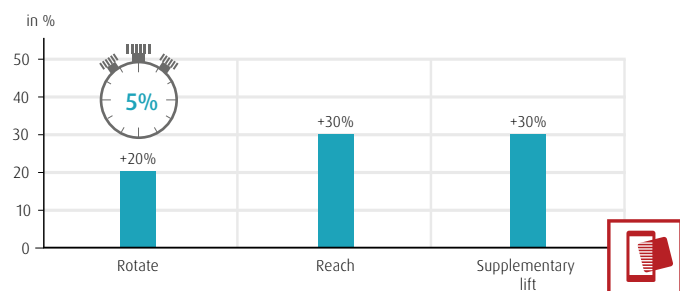

LSC LOAD

A sensor indicates if the forks are carrying a load. LSC Load combines this information with lift height to optimise functions such as reach, rotation and supplementary lift. This allows the truck to operate up to 20 to 30% faster when without a load.

The benefit: up to 5% greater throughput compared with LSC Standard



Here you can find more content via your smartphone: [Linde Augmented Reality App](#)



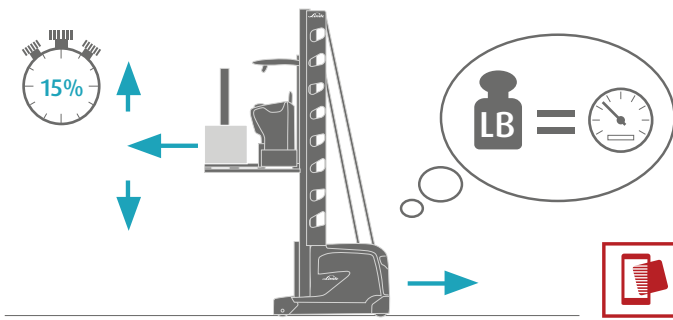

LSC WEIGHT

Equipped with LSC Weight, the truck recognises the total weight of the pallet and its load, and optimises all truck operations accordingly. Light loads can be moved faster than heavy ones. This feature is particularly advantageous in scenarios where loads of differing weights are being handled.

The benefit: up to 15% greater throughput compared with LSC Standard

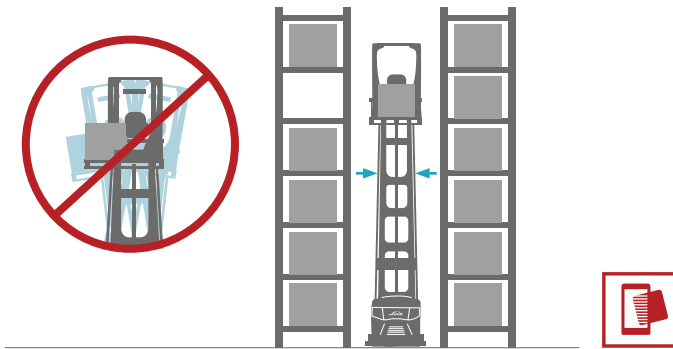

LSC DYNAMIC REACH CONTROL

This combines all other LSC functions, and adds intelligent load stabilisation. When putting away or retrieving loads, it adjusts reach according to current load weight, and eliminates lateral mast oscillations. This enables loads to be moved faster, and reduces damage to loads and racking.

The benefit: up to 20% greater throughput compared with LSC Standard

ADDITIONAL OPTIONS

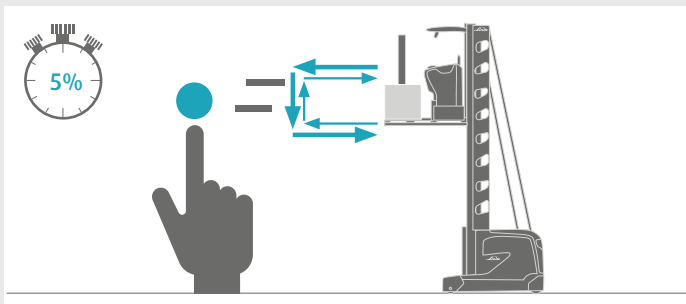

AUTOMATIC FORK CYCLE

With this additional feature, fork extension (reach out), put-away / retrieval and fork retraction (reach back) are performed automatically in the form of a continuous cycle activated by single button.

The benefit: approx. 15% faster put-away / retrieval, and up to 5% greater throughput

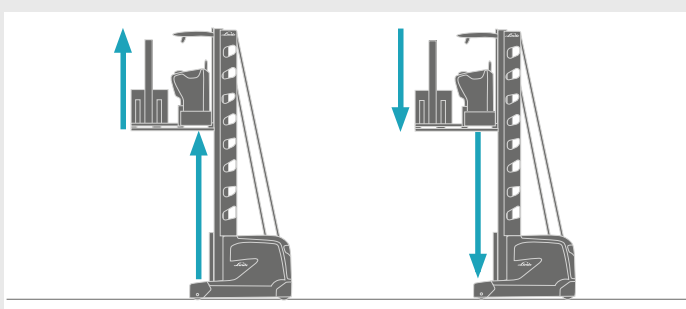

PARALLEL LIFTING AND LOWERING

Upward and downward main and supplementary lift operations can be performed at the same time simply by activating the supplementary lift button when raising/lowering the main mast. The operator always remains at a convenient eye-level with the forks, making it easier for them to manoeuvre the load.

The benefit: faster, simpler fork positioning, especially at the highest and lowest levels of racking

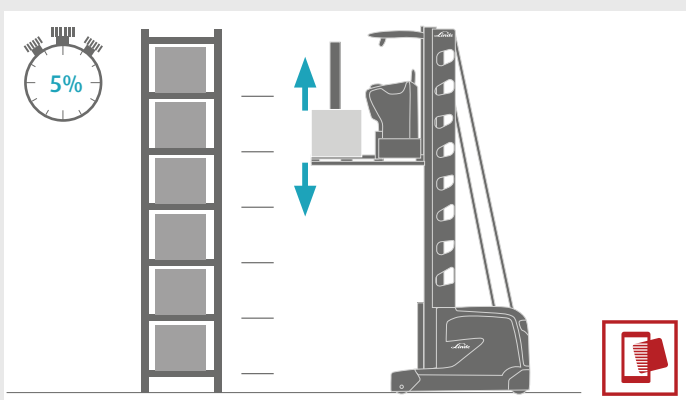

LIFT HEIGHT PRESELECTION

The lift height preselector allows the various rack heights to be quickly and easily saved in the system's memory. Subsequently, the driver only needs to enter the next rack destination, and the forks will be raised automatically to the required height. What's more, when combined with LSC Load, Weight or Dynamic Reach Control, the truck is able to detect the presence of a pallet on its forks, and will then stop 100 mm above the rack if a pallet is to be put away, or at the height of the pallet opening if it is to be retrieved.

The benefit: the forks reach the correct height nearly twice as fast, and throughput is improved by up to 5%

OPERATOR ASSISTANCE SYSTEMS

Linde offers a choice of operator assistance systems that improve the safety of the driver, and of all other warehouse workers. The standard solution is end-of-aisle braking, implemented by means of magnets, RFID tags or barcodes, but additional functions are possible.



Magnet



RFID



Barcode

END-OF-AISLE BRAKING

All Linde VNA truck solutions are equipped with a system that recognises the end of the aisle, or a wall, by means of magnets, RFID transponders or barcodes. The truck then automatically slows down or stops completely, as required.

ADDITIONAL FUNCTIONS

The RFID transponders or barcodes can be employed to deliver additional information and enable further functions, for example as part of Aisle Safety Assist.



AISLE SAFETY ASSIST (ASA)

The Aisle Safety Assist (ASA) system stores the configuration of each aisle and controls truck behaviour accordingly.

Similar to a driver assistance system in a car, ASA supports the operator, helping to avoid damage to the truck, the load and the working environment. The system enables optimum operator performance even under time pressure.

How ASA works

In some areas of a warehouse, there may be constraints on how the truck is permitted to operate (lift height, speed of travel, etc.). Height restrictions are common, for instance, as a result of lighting or roof beams, but only in certain aisles, etc.

The solution is able to create defined three-dimensional zones that the truck recognises. RFID transponders or barcodes are employed to indicate the truck's exact horizontal position. This is combined with the vertical position of the cabin and forks via the integrated lift height measuring system. By entering a predefined zone, it is then possible to impose corresponding restrictions on truck movements, such as travel and lift speed, lift height, and fork reach, in accordance with potential dangers.

For instance, truck speed can be automatically reduced for critical areas, i.e. when driving over expansion joints. This helps to avoid damage to the wheels, dislodging of goods on the pallet, and means a more pleasant and safer ride for the operator.

Defining zones with Aisle Safety Assist has the following benefits:

- Permanent obstacles, such as steel joists or sprinklers, will not be at risk of damage from the truck.
- Truck behaviour can be aligned with the requirements and constraints of specific aisles, ensuring safe and efficient operation at all times.

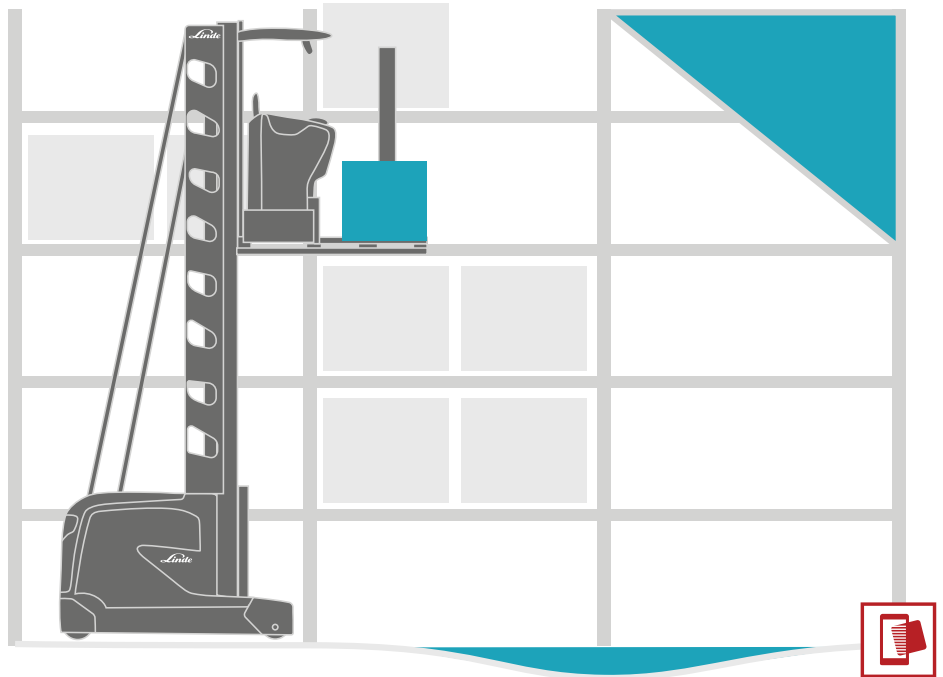

VNA NAVIGATION

Safety and speed do not need to be in conflict. The Linde VNA navigation system allows increased throughput and, at the same time, safe pallet handling by preventing operator error. The truck is notified of the next pallet put-away or retrieval location, and then moves the pallet by the fastest possible combination of lift and travel.

Time savings with VNA navigation

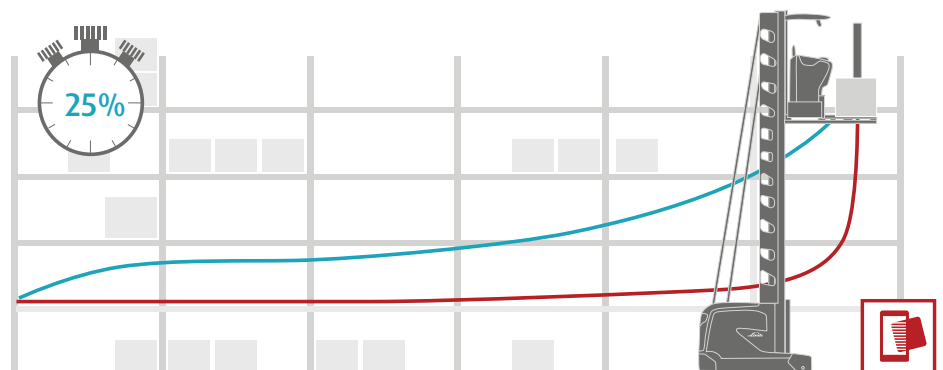

Assisted navigation can deliver time savings of up to 25%. The blue line indicates the ideal line of travel, requiring the least time and energy.



Here you can find more content via your smartphone: [Linde Augmented Reality App](#)



TRUCKS FOR VNA APPLICATIONS



Linde's expertise in designing trucks for VNA applications and our modular approach make us your ideal partner. We have two ranges, ensuring a suitable solution for all situations. In addition, using our exclusive VNAP software, Linde trucks can be customised to your needs.

Our man-down A range is designed for put-away and retrieval of pallets at lower heights. Our man-up combi K trucks are best suited to put-away and retrieval in high-bay warehouses with greater throughput needs and where order picking is required.



The Linde man-up combi K range.

The Linde K range of man-up trucks is perfect for all VNA warehouse applications. These modular combi trucks are designed for handling full pallets and order picking at lift heights of up to 59 ft.



The Linde man-down A range.

Linde's A range of modular man-down trucks is designed for fast, reliable put-away and retrieval of full pallets. This entry-level model for lower-height VNA tasks can work at up to 33 ft.



THE LINDE MAN-UP COMBI RANGE CAN BE TAILORED TO YOUR SPECIFIC VNA NEEDS



Not all warehouses are the same, and VNA requirements vary greatly. Parameters such as mast lift height, battery capacity, cabin configuration, etc. may seem relatively unimportant. But only the right combination will meet your particular needs, and guarantee optimum efficiency.

CUSTOMISATION AT ITS BEST

Against this backdrop, Linde's man-up combi K range was conceived from the outset as a modular offering. Many of these attractive options are also available for our man-down A range. Linde's specialist VNA sales staff will work with you to identify the ideal configuration for your operational and storage needs.





Diverse cabs

Linde cabs are designed to ensure more space and greater freedom of movement. All Linde VNA trucks are fitted with a combi cab as standard. Optional extras include a comfort cab, glass doors and a tilting barrier for easier access to the target picking position. There is even a purpose-made cabin for cold storage scenarios. With Linde, you can be sure of a truck equipped with a cabin that is perfectly suited to your warehouse.

Masts

The ideal mast depends on the application – are your loads light or heavy, do you store pallets at medium heights or up to 59 ft? No matter what your requirements, Linde has a solution.



Operating control concept

Choose between two operating control concepts, in line with your particular truck use case.

Power packages

Your truck can be configured with various travel and lift speed combinations, depending on your working heights and throughput.



Load handling and truck guidance

The Linde modular concept is geared to facilities that primarily handle full pallets or order picking, and where there is a need to make better use of available space. You can choose between a rotating turret head or telescopic forks, and between rail or wire guidance, in line with the operational criteria of your existing or new-build warehouse.

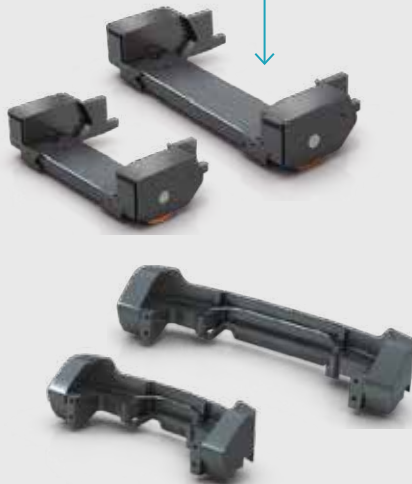

The optimum chassis size

Compared with conventional combi trucks, Linde models are extremely robust, torsion-resistant and compact, allowing reduced chassis length. They set new standards in terms of rapid guide wire recognition and capture, and truck turning circle. As a result, it is possible to reduce the size of the transfer aisle and aisle width.

Batteries

Ideal battery capacity is determined by the length of the normal work shift, load weight and throughput. We will equip your truck with exactly the right battery for you.



ACTIVE STABILITY CONTROL



Especially in VNA warehouses, the quality of the floor surface plays a crucial role when it comes to truck productivity. With Active Stability Control, maximum speed and material-handling throughput is possible even on floors that do not comply with VDMA standards.

THE CHALLENGE WITH UNEVEN SURFACES

Floor conditions have a major impact on intralogistics efficiency. In high-racking warehouses served by VNA trucks, where lifting heights of up to 59 feet are possible, there is very little space between truck and rack. In this instance, unevenness of just a few millimetres can cause dangerous swaying. This has been a significant problem for many warehouse operators in the past. Active Stability Control (ASC) resolves this issue.

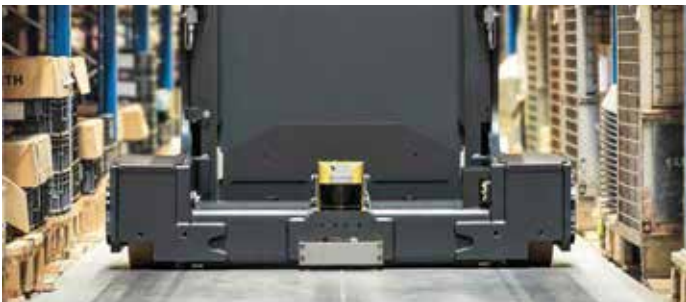

ASC tackles the problem where it originates: at floor level.

THE SOLUTION WITH ASC

Active Stability Control continuously scans the floor surface by means of an intelligent combination of mechanical and electronic sensors. If the system detects surface irregularities, the load wheels are adjusted immediately to prevent the truck from swaying. The truck is therefore kept in a safe and stable state at all times.

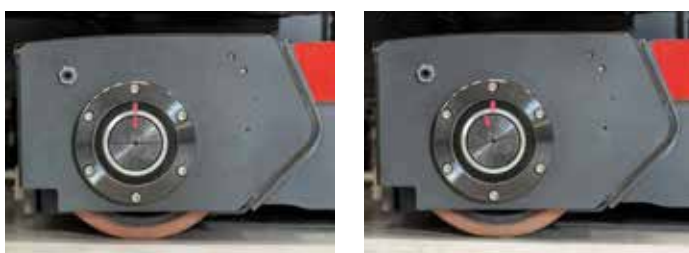

Where unevenness is detected, the height of the left-hand and right-hand load wheels is automatically adjusted to prevent the truck from swaying.

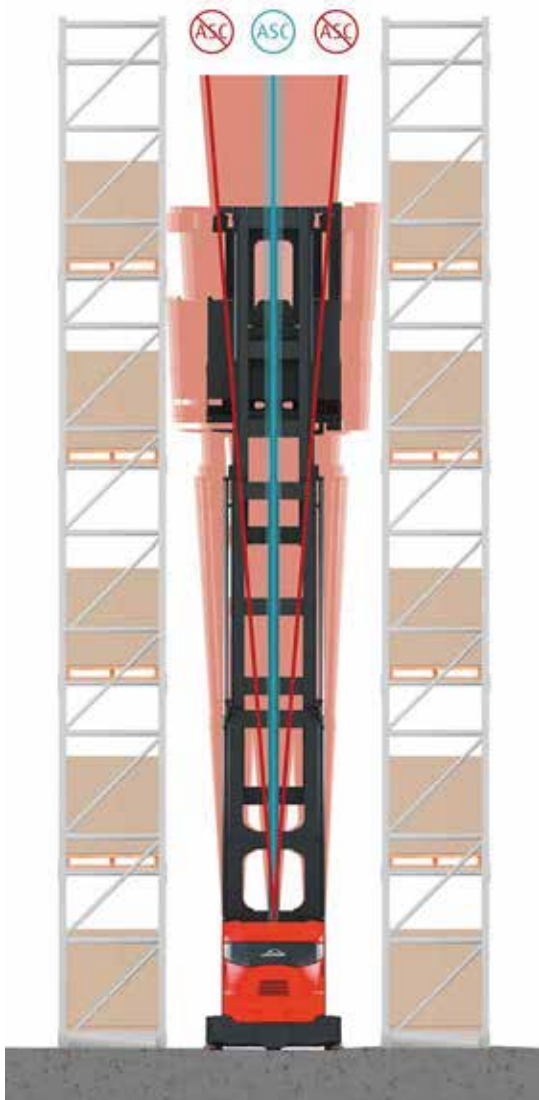

SAFETY, EFFICIENCY AND ERGONOMICS

Active Stability Control was developed to ensure K trucks enjoy maximum stability and deliver maximum productivity, even when the floor does not fulfil VDMA specifications. ASC is able to compensate for a difference in height between the left-hand and right-hand load wheels of up to ten millimetres, ensuring the truck is always a sufficient distance from the racks. It is possible to safely handle materials at heights of up to 59 feet, and to drive at speeds of up to 9 mph.

This greatly reduces mast swaying, and helps create an ergonomic working environment for the driver. K trucks can be supplied with ASC ex works. But trucks can also be preconfigured to allow the system to be retrofitted at a later date. ASC can therefore be deployed for both existing and new-build warehouses.

ASC can be deployed in new-build and existing warehouses. You can order a truck with ASC, or preconfigured for retrofitting ASC at a later date.

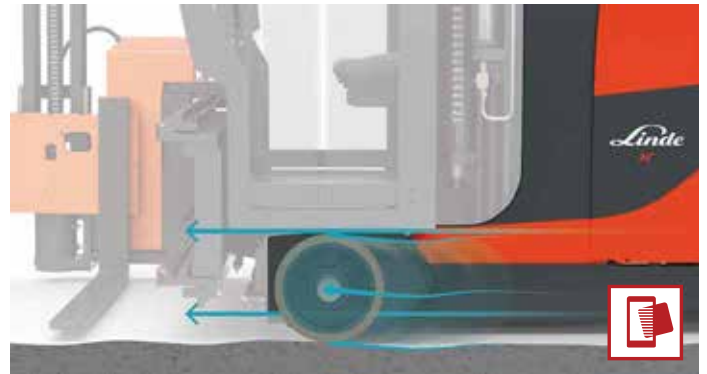

High performance, high stability

ASC enables the full driving speed in accordance with the VNAP truck configuration, with maximum speeds of up to 9 mph and lifting heights of up to 59 feet on floors that do not fulfil VDMA specifications in terms of evenness.

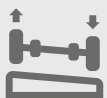

Adjusts for uneven floors

It is possible to adjust for a discrepancy of up to ten millimetres between the left-hand and right-hand drive lanes, guaranteeing a safe distance between truck and racking.



Compliance with DIN 18202 can be sufficient

This means that a floor quality to the lesser requirements of DIN 18202 (table 3, line 3) can be sufficient, as ASC prevents lateral swaying. The operator can therefore drive the truck quickly yet safely.



Here you can find more content via your smartphone: [Linde Augmented Reality App](#)



EQUIPMENT CHOICES FOR THE MAN-UP COMBI K RANGE CABIN



The equipment fitted as standard to Linde's man-up combi K range basic model offers significantly greater operator comfort and convenience than typical competitor models.

And the more ergonomic the working environment, the more productively people work. This includes easy on/off access as standard, plus an optional kneepad, which is ideal when the operator is standing. It is also possible to add LED lighting, and a flexible mounting system suitable for a variety of Linde and non-Linde items, such as screens and storage compartments.



Mirror module

There is a choice of mirrors, giving you great all-round visibility.



LEDs

You can optionally install bright LED working lights to guarantee racking is clearly visible. The powerful ventilation fans for the mirror module come with two settings, and are also optional.

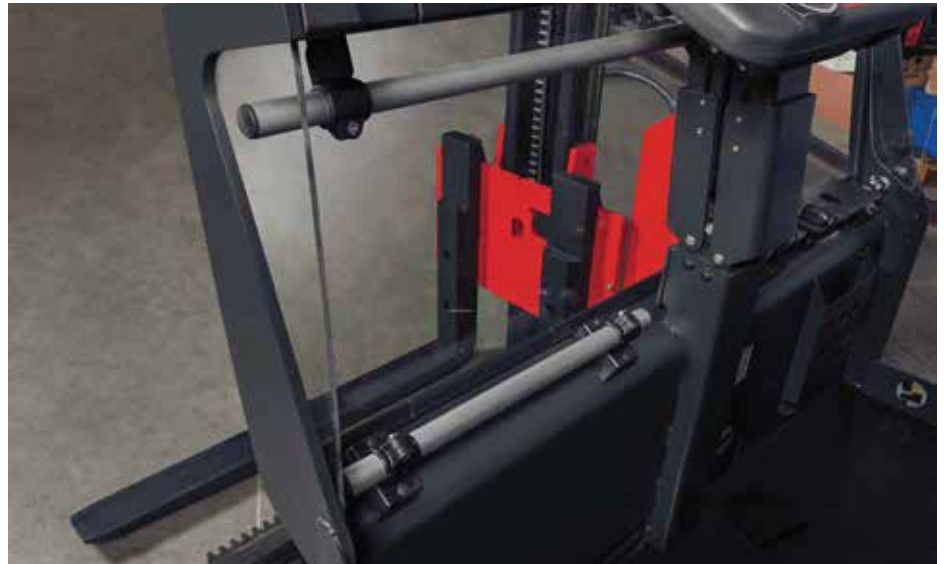

Flexible mounting and storage system

The mounting system allows truck-specific installation of many devices, including screens, scanners, storage compartments, clipboards, etc.



Storage

Convenient storage of bottles, tools, etc.



Access

Low step-in height as standard for easy on/off access.



Ergonomic kneepad

Optional kneepad for easy, ergonomic placement of picked goods onto the pallet.

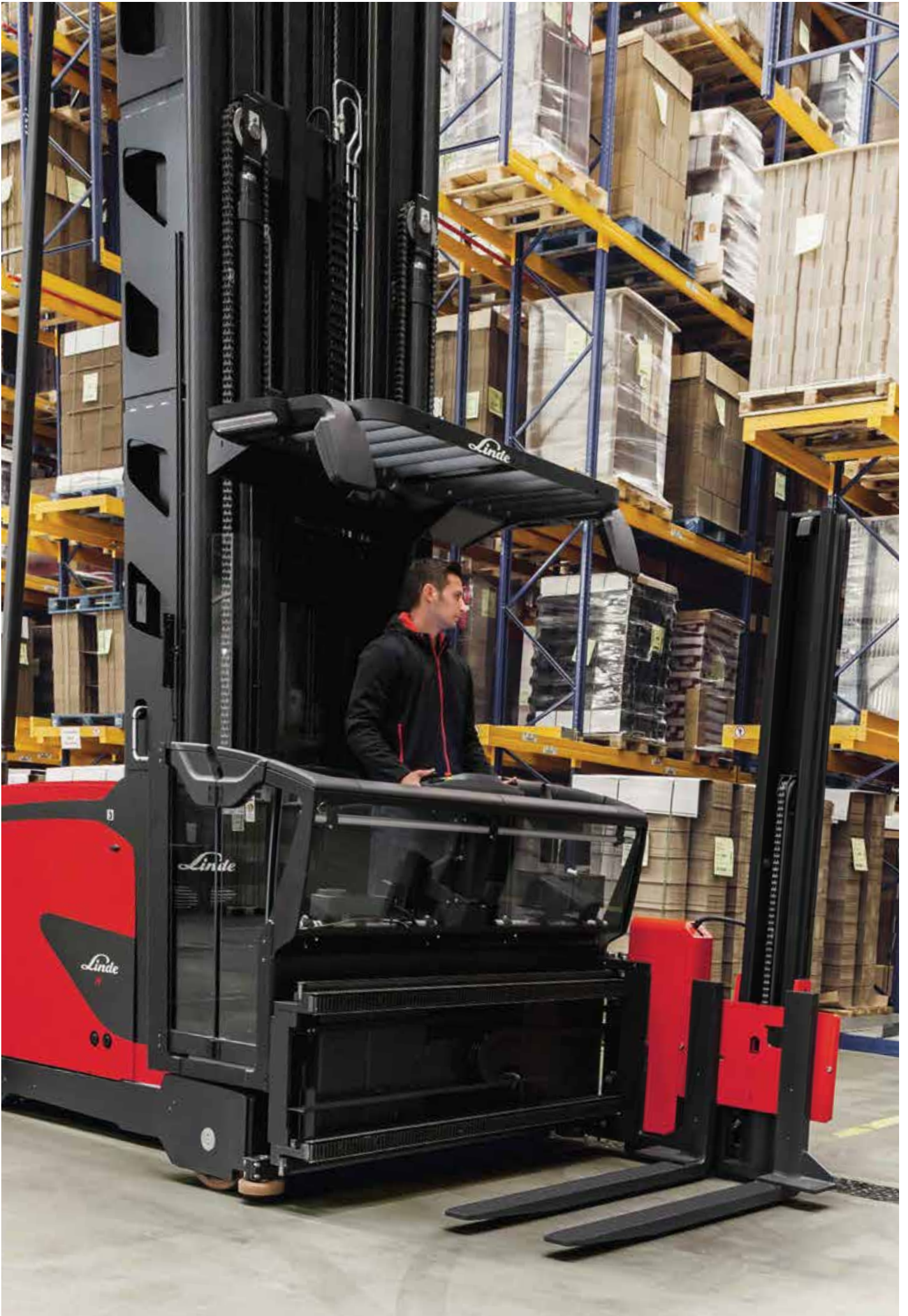

FURTHER EQUIPMENT OPTIONS FOR THE CABIN

Linde enables you to fully tailor the cabin to your needs. Is your warehouse heated? Is there a large amount of order picking involved?

You can choose a form of cabin access that meets your specific requirements. The side barriers are extremely robust, but open easily for convenient entry/exit. The comfortable cushioning supports the operator when leaning over the barriers.

The tilting barrier is ideal for order picking when goods are located at the back of the pallet. By tilting the barrier, the operator can reach about 20 inches further. To ensure safety, the barrier can only tilt forward when the truck is stationary, and truck travel is only possible when the barrier is tilted back.

The optional glass doors add significant value in unheated warehouses as the operator is shielded from wind and drafts.



Tilting barrier

Tilting barrier for better access to cases at the back of the pallet. This enables the operator to comfortably extend their arm by approximately 20 inches



Glass door

Protection against wind and drafts makes for a better working environment.

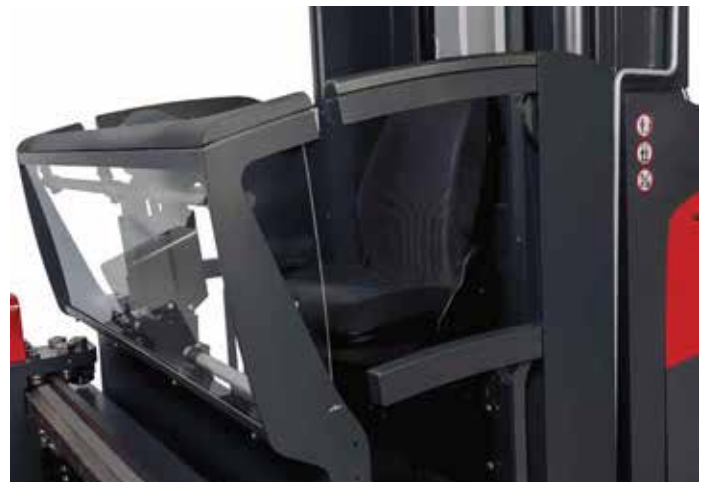

Lateral barriers

Cushioned barriers for easy, comfortable order picking.

A SOLUTION TO ALL NEEDS VIA TWO CONTROL CONCEPTS

Modularity and flexibility are a must for solutions that can be geared to diverse requirements. Linde therefore offers two control systems, accommodating various needs.

Standard all-in-one control or split controls: with split controls, the operator has better visibility on account of the more compact display. Seated and standing operation with both control types is possible.

In both instances, the ergonomic Linde control panel guarantees ease of use and high productivity. Contact sensors ensure safe, two-handed operation of the truck at all times. All functions are within easy reach.

STANDARD ALL-IN-ONE CONTROL PANEL



The all-in-one control panel can be easily adjusted in terms of height, tilt and angle to suit the individual operator. The full graphical display shows all relevant information, such as time, lift height, speed, load weight and battery charge.



Seated operation ensures easy handling of full pallets.

SPLIT CONTROLS



The controls in the armrests can be quickly and easily switched between standing and seated operation. Contact sensors guarantee two-handed truck operation at all times. The control panel is highly compact, for a greater field of view.



Standing operation is often preferred for frequent order picking.



AUTOMATED K-MATIC TRUCK



The most cost-effective solution is often a fully automated truck. The Linde Matic portfolio offers trucks for almost any scenario. Supported by the Linde navigation system and sensors, the K-MATIC can operate entirely autonomously within the aisle.

FULLY AUTOMATED

Thanks to smart safety management, the K-MATIC anticipates and responds autonomously to its direct environment. Robust navigation technology supports your business 24/7 while offering significant cost savings. A computerised remote diagnostics system, combined with a maintenance software solution, helps you to keep the K-MATIC up and running. This truck can operate at heights up to 39 feet, or can be deployed to feed a conveyor belt.



3D pallet detection via camera



Real-time truck position detection



Integration

Linde's automation technology can be seamlessly integrated into your existing IT and logistics infrastructure.



Cost-efficiency

In conjunction with navigation technology, Linde's K-MATIC is an effective way of streamlining your internal material flows and significantly cutting costs.



Scalability

The system can be extended to automate your entire warehouse or the supply of materials to production.



Flexibility

Equipped with Linde's geo-navigation system, the K-MATIC uses existing structures, such as racking, to reliably plan its route.

STATE-OF-THE-ART LI-ION BATTERY TECHNOLOGY



VNA trucks must overcome a variety of challenges, including the need for high availability and cost-effectiveness. Linde Li-ION batteries offer fast charging, high energy efficiency, a very long product service life as well as zero maintenance and emissions.

POWERING VNA TRUCKS

Linde Li-ION technology was developed in close collaboration with battery manufacturers to achieve high performance. As a result, 2,500 full charging cycles are possible with just 20% residual charge. Combined with greater battery efficiency, this guarantees altogether higher usable battery capacity for the customer. The system as a whole, consisting of truck, battery and charger, is CE-certified. To identify the best solution for each customer, Linde has developed a calculator that simulates power consumption and charging time. Batteries and chargers are available in a choice of two versions (48V/90V).



Short, fast top-up charging:
battery can be charged during short breaks, resulting in higher truck availability.



Reduced emissions:
no leaking of hazardous battery gases and acids.



No more battery replacement:
save time and costs as spare batteries and battery changing areas are no longer necessary.



Maintenance-free operation:
no need to clean or fill with water.

THE LINDE MAN-UP COMBI K RANGE

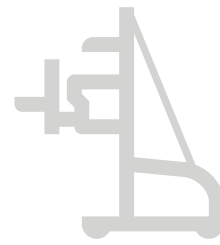

A modular offering that ensures your very own tailor-made solution.

COMFORT

Linde's man-up trucks provide the highest standards of comfort, safety and reliability. We are an operator-focused manufacturer. As a result, operators immediately feel at ease as soon as they drive a Linde K truck. We strongly believe the more comfortable, functional and ergonomic the truck is, the more relaxed and efficient the operator will be. Features such as the glass front panel and doors ensure excellent visibility and protection against wind and drafts.

SAFETY

The control panel was designed to ensure safe, intuitive fatigue-free operation. The full graphical display provides all relevant information, such as time, lift height, load weight and driving speed, at all times. Integrated touch sensors enforce two-handed operation. In conjunction with the Linde warehouse navigation system, the display indicates key operating parameters, such as load weight, the status of wire guidance and the current and target positions. In addition to LSC for speed and stability control, Linde K trucks benefit from two independent braking systems: electric regenerative braking activated when the operator's hand releases the accelerator or changes direction; and a two-stage electromagnetic spring-loaded parking and emergency brake acting on the motor shaft. The innovative rescue alarm detects unusual operator behaviour, and attracts attention via a flashing beacon and sounding a horn in the event of an emergency.

RELIABILITY

Linde's K range is exceptionally reliable, and requires very little servicing or maintenance.

PRODUCTIVITY

The modular design ensures a tailor-made solution for any application. The cabin was developed with ergonomics front of mind, and to ensure that the operator has an excellent view of pallets when seated.

ENERGY

The energy recovery system ensures a longer-lasting battery charge. Intelligent power management, for example monitoring maximum battery current draw, helps extend the battery's life.

→ **Linde Li-ION batteries** offer greater user-friendliness, energy efficiency and rapid charging

INTELLIGENCE

Innovative assistance systems guarantee high throughput and safe load handling at all times.

- **Active Stability Control (ASC):** The Active Stability Control system ensures K trucks remain steady and safe. By means of electro-mechanical sensors, it identifies and automatically makes adjustments for unevenness of the aisle floor. This allows the truck to travel at up to full speed over floors that do not comply with VDMA standards
- **Linde System Control (LSC):** The standard system recognises the lift height and displays the corresponding load capacity. Optional LSC Load and LSC Weight features optimise all truck movements, such as driving speed, lifting, reach and rotation in accordance with current lift height, load presence and load weight
- **Dynamic Reach Control:** Effectively prevents lateral mast movements while reaching, plus reach adjustment in line with lift height and load weight
- **Aisle Safety Assist (ASA):** Truck behaviour, including driving speed, lift stop and end-of-aisle braking, is automatically adjusted to the characteristics of each warehouse aisle
- **Linde VNA Navigation:** This calculates the shortest and fastest route to the next destination, and minimises power consumption. It eliminates errors, such as putting away or retrieving the wrong goods to/from the wrong position
- **Automatic Fork Cycle:** Fork extension (reach out), put-away/retrieval and fork retraction (reach back) are performed automatically as a continuous cycle, activated by a single button
- **Lift Height Preselection:** The various rack heights can be easily entered into the system memory: The operator only needs to enter the next destination, and the forks will be raised to the required height



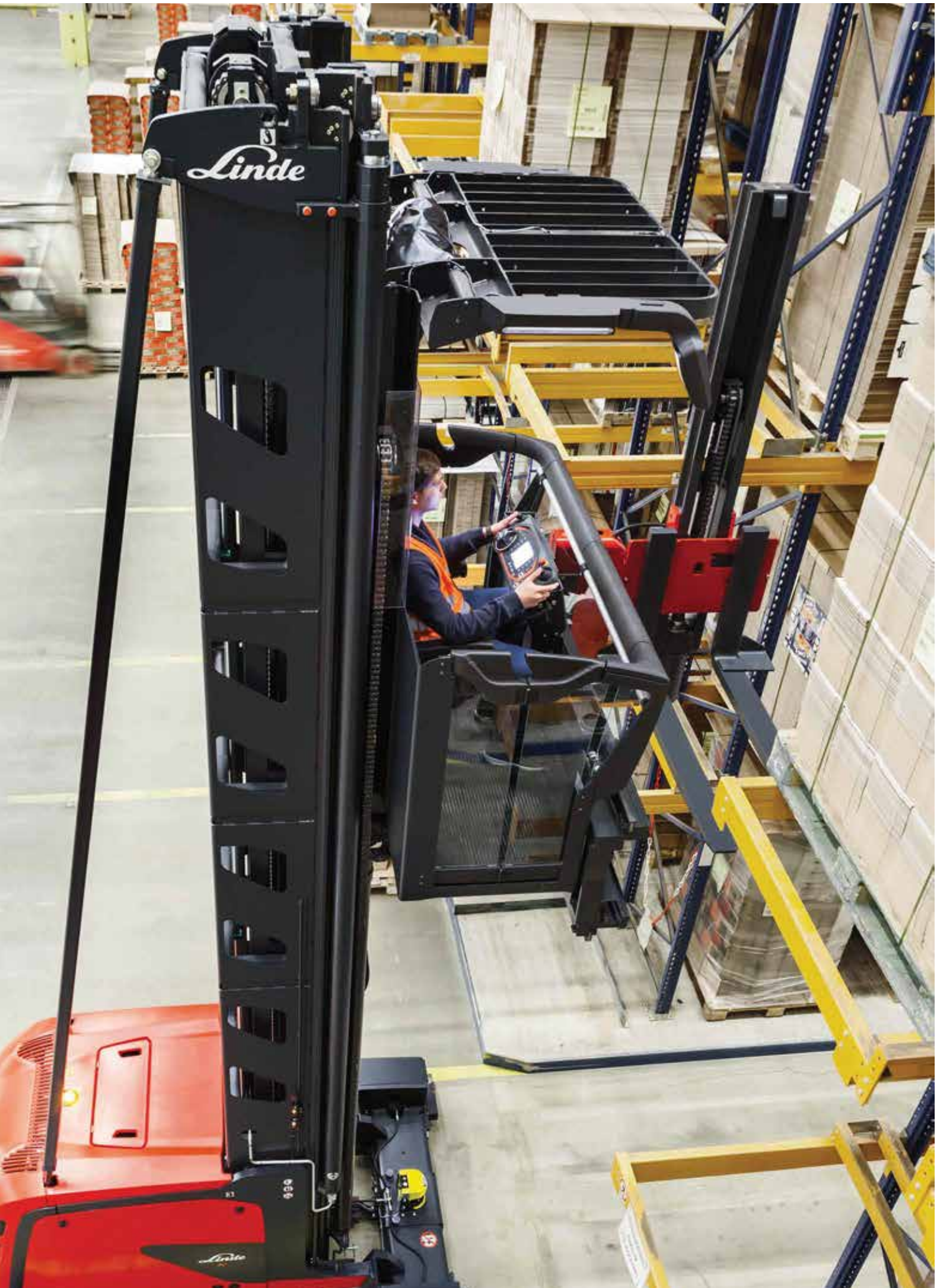

EQUIPMENT OPTIONS FOR LINDE MAN-DOWN A RANGE



You have a choice of equipment features, including masts, motor type, lift height, etc. But we can also provide a variety of interesting extras for the cabin of your man-down A truck. The basic model is already equipped with a hydraulically damped seat and innovative joystick control. Options include a video camera or twin pedal control. Create a made-to-measure answer to your intralogistics challenges.



Seat
Hydraulically damped seat with lumbar support. The seat can be vertically and horizontally adjusted to deliver full visibility when putting away or retrieving pallets. Also available with an optional heater.

Joystick control
User-friendly, one-hand-operated joystick that controls all relevant functions.



Storage compartments

A variety of useful storage compartments.



Video camera

Excellent visibility for put-away and retrieval of full pallets at height.



Radio mount

For a pleasant working environment.



Laser pointer

Faster positioning of the load with the Linde laser pointer system.



THE LINDE MAN-DOWN A RANGE FOR OPTIMUM EFFICIENCY IN VERY NARROW AISLES



COMFORT

The A range benefits from Linde's operator-centric philosophy, with an emphasis on ergonomics, convenience and comfort. The cab is designed to meet all operator needs, and to enable them to effectively perform their tasks. The adjustable seat and pedals ensure a fatigue-free operating position. The joystick allows all functions to be accessed without having to switch from one hand to another. Overall, the result is great comfort and high productivity.

SAFETY

Multiple features, such as the optional camera system for driving and stacking, contribute to accident prevention. The optional laser pointer indicates the exact position of the forks, helping the operator to put away or retrieve pallets quickly and safely.

RELIABILITY

Linde's man-down range features sealed, maintenance-free motors with the latest AC technology. The trucks are effectively protected against dust and dirt, and fully enclosed. And in the event of a fault, Linde has an extensive and responsive service network.

PRODUCTIVITY

The sideways seating position means excellent visibility, helping the operator achieve high pallet throughput. Powerful truck travel and lift motors guarantee high productivity. The Linde System Control (LSC) calculates the optimum speed in real time in relation to the load - for maximum throughput.



Linde Material Handling ranks among the world's leading manufacturers. This position has been justly earned. Linde trucks excel not only with their recognized innovative technology but especially their low energy and operating costs, which can be as much as 40% less than competitors.

High quality in production is matched by the standard of the services we provide. With a comprehensive network of local sales partners, we are at your call around the clock and around the world.

Your local Linde partner offers you a complete single-source package. From qualified pre-sales consulting through the sale to after-sales service; including finance packages matched to your business requirements. Leasing, rental or hire purchase. Flexibility is maintained in your operational and decision-making processes.

LINDE – FOR YOUR PERFORMANCE



TOTAL
WAREHOUSE
TotalWarehouse.com
833-868-2500